

# 1006 Series Electric Strike

*Works with all cylindrical and mortise locksets with or without a deadbolt*

Also available in Complete One Box Solution



## The strongest, most versatile electric strike available.

The HES 1006 series is the strongest and most versatile electric strike available. The dual interlocking plunger design and heavy duty stainless steel construction, enables it to exceed every standard developed for electric strikes. With multiple faceplate options, the 1006 will fully accommodate every lock designed to work within an ANSI 4-7/8" strike plate. Tested to exceed 3,000 lbs. of static strength, 350 ft-lbs. of dynamic strength and factory tested to exceed 1,000,000 cycles of operation, the 1006 is in a class of its own.

### Features

- Stainless steel construction
- Tamper resistant
- Static strength 2,500 lbs. (fail secure)
- Dynamic strength 350 ft-lbs. (fail secure)
- Endurance 1,000,000 cycles
- Fail secure (standard)
- Non-handed
- Accommodates up to 1" [25.4mm] deadbolt
- Plug-in connector
- Full keeper shims for horizontal adjustment
- Trim enhancer
- Strike body depth 1-11/16" [43mm]
- SecuriCare five-year, no-fault, no questions asked warranty (Addition of SMART Pac® III extends the warranty to 10 years)

### Options

- LBM - Latchbolt monitor
- LBSM - Latchbolt strike monitor
- Fail Safe
- Interchangeable faceplates
- Monitor switch may not work with all faceplate options

### Accessories

- 157 Torx® screws
- 1000-102 Rain guard
- 1006-103 Full Keeper Shims
- 1000-104 Lip Extension Trim Adapter
- 1006-105 Trim Enhancer
- 1000-110 Replacement Strike Plate
- 1000-130 KD Filler Plate
- 150 Strike Latch Guard
- HESCUT-MTK Metal Template Kit
- 2005M3 SMART Pac® III



Grade 1



SecuriCare Warranty



Mortise Locks with Deadbolt



Mortise Locks without Deadbolt



Cylindrical Locksets



Specialty Locksets



Dual Voltage 12/24



Fire Rated



Windstorm Resistant



Outdoor Rated



Burglary Rated



# 1006 Series Electric Strike

## Certifications

- ASTM E152 Fire Door Compliant
- ASTM E330 Certified
- ANSI/BHMA A156.31, Grade 1
- ANSI/SDI 250.13 Certified
- Florida Building Code Approved FL# 16392
- NFPA-252 Fire Door Compliant
- RoHS Compliant
- UL 10C Fire Rated
- UL 294 Listed
- UL 1034 Burglary-Resistant Listed and Suitable for Outdoor Use

## Specifications

### Frame Application

- Metal
- Wood

### Electrical

- Dual Voltage 12/24 VDC
- 480 mA at 12 VDC
- 240 mA at 24 VDC

## Dimensions

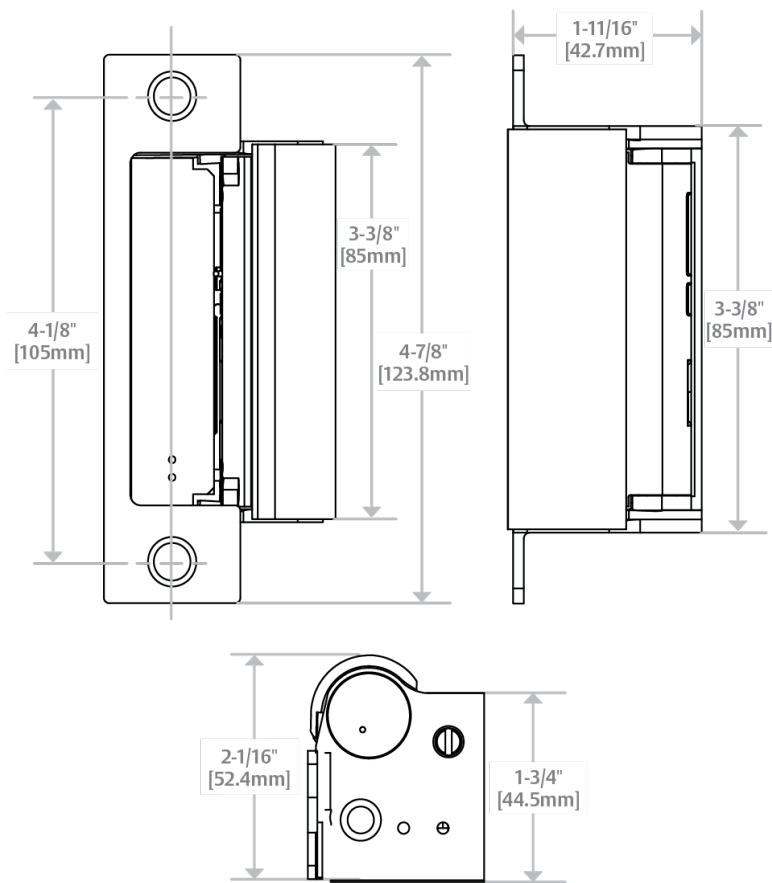

Diagram shown with DB faceplate

NOTE: DC must be well filtered with ripple less than 1 volt 12 ms.

## How to Order

SERIES	MODEL	FAIL SECURE / SAFE	FINISH*	OPTION (S)
<b>1006</b>	—	<b>- F</b>	<b>- 630</b>	<b>- LBM</b>
<b>1006</b> Universal Electric Strike	<b>(blank)</b> Electric strike body only, faceplates ordered separately	<b>(blank)</b> Fail Secure (standard)	<b>605</b> Bright Brass	<b>(blank)</b> No Monitor
	<b>CS*</b> Complete Electric Strike; includes the SMART Pac III and J, KD, KM, HM, ND faceplates and brackets	<b>F</b> Fail Safe	<b>606</b> Satin Brass	<b>LBM</b> Latchbolt Monitor**
	<b>CLB*</b> Complete Electric Strike for latchbolt locks; includes J, K, KD and KM faceplates		<b>612</b> Satin Bronze	<b>LBSM</b> Latchbolt Strike Monitor**
	<b>CDB*</b> Complete Electric Strike for Deadbolt Locks; includes the ND and HM faceplates		<b>613E</b> Dark Oxidized Satin Bronze Powder	
	<b>CAS*</b> Complete Electric Strike for Deadbolt Locks; includes the N, ND and NM faceplates		<b>629</b> Bright Stainless Steel	
			<b>630</b> Satin Stainless Steel	
			<b>BLK</b> Black	

\*Complete Pacs are only available in the 630 finish. \*\* Not available with CS, CDB, or CAS

NOTE: Electric strike compatibility is determined at time of electric strike product release. ASSA ABLOY is not responsible for incompatibility of products that have changed in design or craftsmanship by their respective manufacturers. When compatibility is a concern, contact Customer Support for application assistance.

## 1006CS Smart Strike™

*The Complete One Box Solution for all cylindrical and mortise locksets, with or without a 1" deadbolt*

The 1006CS Smart Strike includes a 1006 electric strike body and SMART Pac® III plus faceplates and brackets that can provide the same function as any of the following options:

J Option	H Option	HTD Option
K Option	HD Option	N Option
KD Option	HM Option	ND Option
KM Option	HT Option	NM Option

### Compatible Locksets

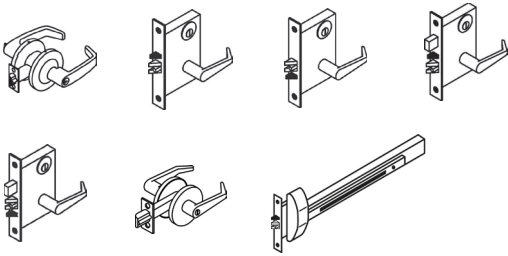

## 1006CLB Complete for Latchbolt Locks

*The Complete One Box Solution for all cylindrical and mortise locksets*

The 1006CLB includes the 1006 electric strike body plus faceplates and brackets that provide the same function as any of the following options:

J Option	KD Option
K Option	KM Option

### Compatible Locksets

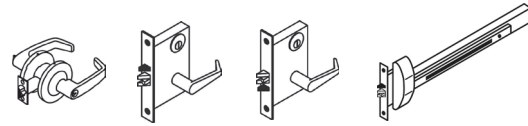

## 1006CAS Complete for Recapture

*The Complete One Box Solution for deadbolt recapture*

The 1006CAS Smart Strike includes a 1006 electric strike body plus faceplates and brackets that can provide the same function as any of the following options:

A Option	N Option	T Option
AD Option	ND Option	TD Option
AM Option	NM Option	

### Compatible Locksets

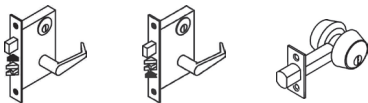

## 1006CDB Complete for Deadbolt Locks

*The Complete One Box Solution for all locksets with a 1" deadbolt*







The 1006CDB includes the 1006 electric strike body plus faceplates and brackets that provide the same function as any of the following options:

H Option	HT Option	ND Option
HD Option	HTD Option	NM Option
HM Option	N Option	

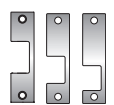
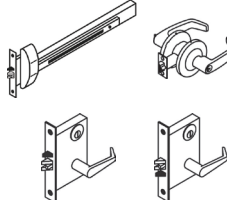

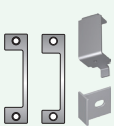
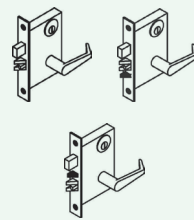

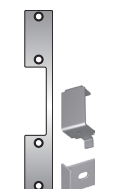
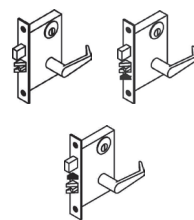

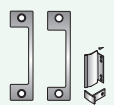
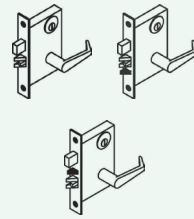
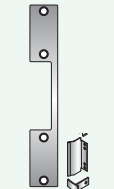
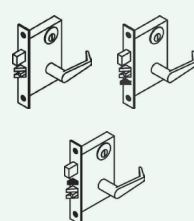





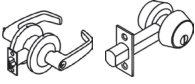

### Compatible Locksets

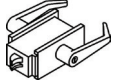

# 1006 Series Faceplate Options





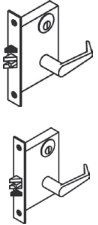







<p><b>OPERATION</b></p>	 <p>Mortise Locks with Deadbolt</p>	<p>Latchbolt and deadbolt are released by a single keeper. The keeper is held open to recapture the latchbolt and deadbolt when the door is closed.</p>	
 <p>4-7/8" × 1-1/4" [123.8mm x 31.75mm]</p>		<p><b>LB Option</b>  <b>The Latchbolt Solution:</b> Includes all hardware to accommodate every cylindrical and mortise lock up to a 3/4" [19mm] latchbolt  <i>Replaces function of the J, K, KM and KD Options.</i>                      ANSI/BHMA Numbers: E09321, E09322, E09323</p>	
<p><b>OPERATION</b></p>	 <p>Mortise Locks with Deadbolt</p>	<p>This deadbolt solution offers two modes of functionality; night latch and lockout. (Functional operation modes described below.)</p>	
 <p>4-7/8" × 1-1/4" [123.8mm x 31.75mm]</p>		<p><b>DB Option</b>  <b>The Deadbolt Solution:</b> Includes all hardware to retain and release all mortise and cylindrical locks with up to a 1" deadbolt  <i>Mode 1: Night latch function. The deadbolt is retracted during traffic hours. The latchbolt is released by the keeper and keeper returns to the locked position.</i>  <i>Mode 2: Lockout function. The electric strike will not release if the deadbolt is extended.</i>                      Replaces function of the N, ND, NM, H, HD, HM, HT, and HTD options                      ANSI/BHMA Numbers: E09391, E09392, E09393, E09331, E09332, E09333</p>	
<p><b>OPERATION</b></p>	 <p>Mortise Locks with Deadbolt</p>	<p>This deadbolt solution offers two modes of functionality; night latch and lockout. (functional operation modes described below.)</p>	
 <p>9" × 1-3/8" [123.8mm x 34.9mm]</p>		<p><b>DB-2 Option</b>  <b>The Deadbolt Solution:</b> Includes all hardware to retain and release all mortise and cylindrical locks with up to a 1" deadbolt. Wood applications.  <i>Mode 1: Night latch function. The deadbolt is retracted during traffic hours. The latchbolt is released by the keeper and keeper returns to the locked position.</i>  <i>Mode 2: Lockout function. The electric strike will not release if the deadbolt is extended.</i>                      Replaces the N-2 and H-2 options                      ANSI/BHMA Numbers: E09391, E09392, E09393, E09331, E09332, E09333</p>	
<p><b>OPERATION</b></p>	 <p>Mortise Locks with Deadbolt</p>	<p>Latchbolt and deadbolt are released by a single keeper. The keeper is held open to recapture the latchbolt and deadbolt when the door is closed.</p>	
 <p>4-7/8" × 1-1/4" [123.8mm x 31.75mm]</p>		<p><b>CAS Option</b>  <b>The Continuous Deadbolt Recapture Solution:</b> Includes all hardware to retain, release and recapture all mortise locks and tubular E Option locks with up to a 1" deadbolt.  <b>Mode:</b> Normally extended deadbolt. Latchbolt and deadbolt are released by a single keeper. The keeper is held open to recapture the latchbolt and deadbolt when the door is closed.                      Replaces the N, ND, NM, A, AM, AD, T and TD options                      ANSI/BHMA Numbers: E09391, E09392, E09393, E09331, E09332, E09333</p>	
 <p>9" × 1-3/8" [123.8mm x 34.9mm]</p>		<p><b>CAS-2 Option</b>  <b>The Deadbolt Solution:</b> Includes all hardware to retain, release and recapture all mortise locks and tubular locks with up to a 1" deadbolt. Wood applications.  <b>Mode:</b> Normally extended deadbolt. Latchbolt and deadbolt are released by a single keeper. The keeper is held open to recapture the latchbolt and deadbolt when the door is closed.                      Replaces the N-2, A-2 and T-2 options                      ANSI/BHMA Numbers: E09391, E09392, E09393, E09331, E09332, E09333</p>	

# 1006 Series Faceplate Options

<p><b>OPERATION</b></p>	 <p>Specialty Locksets</p>	<p>After releasing the latchbolt or deadbolt, the keeper is held open to recapture the bolt as the door is closed.</p>
 <p>4-7/8" × 1-1/4" [123.8mm x 31.75mm]</p>	<p><b>E Option</b> For use with: Corbin Russwin Security Bolt, Weiserbolt and normally extended 1" tubular deadbolts ANSI/BHMA Numbers: E09391, E09392, E09393</p>	
<p><b>OPERATION</b></p>	 <p>Specialty Locksets</p>	<p>The hookbolt is released by a single keeper. The keeper is held open to recapture the latchbolt and hookbolt when the door is closed.</p>
 <p>4-7/8" × 1-1/4" [123.8mm x 31.75mm]</p>	<p><b>R Option</b> For use with: Adams Rite style hookbolt up to 1" throw ANSI/BHMA Numbers: E09391, E09392, E09393, E09332, E09333</p>	
<p><b>OPERATION</b></p>	 <p>Specialty Locksets</p>	<p>After releasing the latchbolt, the keeper returns to the locked position.</p>
 <p>4-7/8" × 1-1/4" [123.8mm x 31.75mm]</p>	<p><b>Z Option</b> For use with: Unit and Mono locks ANSI/BHMA Numbers: E09321, E09322, E09323</p>	
<p><b>OPERATION</b></p>	 <p>Cylindrical Locksets</p>	<p>After releasing the latchbolt, the keeper returns to the locked position.</p>
 <p>9" × 1-3/8" [123.8mm x 34.9mm]</p>	<p><b>J-2 Option</b> For use with: All cylindrical locks up to a 3/4" [19mm] latchbolt. Wood applications. ANSI/BHMA Numbers: E09321, E09322, E09323</p>	
<p><b>OPERATION</b></p>	 <p>Mortise Locks without Deadbolt</p>	<p>After releasing the latchbolt, the keeper returns to the locked position.</p>
 <p>9" × 1-3/8" [123.8mm x 34.9mm]</p>	<p><b>KM-2 Option</b> For use with: Mortise locksets up to a 3/4" [19mm] latchbolt. Wood applications. ANSI/BHMA Numbers: E09321, E09322, E09323</p>	

"For use with" information is offered as a recommendation only. Reference should be made to the lockset manufacturer for proper installation instructions necessary to meet compatibility requirements.





# 1006 Series Faceplate Options

<p><b>OPERATION</b></p>	 <p>Cylindrical Locksets</p>	<p>After releasing the latchbolt or deadbolt, the keeper is held open to recapture the bolt as the door is closed.</p>
 <p>4-7/8" × 1-1/4" [123.8mm x 31.75mm]</p>	<p><b>J Option</b></p> <p><b>For use with:</b> Cylindrical locksets up to 3/4" [19mm] throw and all locksets with center-lined bolts.</p> <p><b>Compatible locksets:</b> All brands of cylindrical latchbolts</p> <p><b>ANSI/BHMA Numbers:</b> E09321, E09322, E09323</p>	
<p><b>OPERATION</b></p>	 <p>Mortise Locks with Deadbolt</p>	<p>After releasing the latchbolt, the keeper returns to the locked position.</p>
 <p>4-7/8" × 1-1/4" [123.8mm x 31.75mm]</p>	<p><b>KD Option</b></p> <p><b>For use with:</b> Mortise locksets up to 3/4" [19mm] throw latchbolt.</p> <p><b>Compatible locksets:</b> Dorma 9500, Jackson, Sargent (7700 &amp; 8100), Schlage, ASSA ABLOY ACCENTRA™* (8700)</p> <p><b>ANSI/BHMA Numbers:</b> E09321, E09322, E09323</p>	
 <p>4-7/8" × 1-1/4" [123.8mm x 31.75mm]</p>	<p><b>KM Option</b></p> <p><b>For use with:</b> Mortise locksets up to 3/4" [19mm] throw latchbolt.</p> <p><b>Compatible locksets:</b> Accurate, Arrow, Baldwin, Best, Corbin Russwin, Falcon, Marks, PDQ, Sargent (7800, 8200 &amp; 9200), ASSA ABLOY ACCENTRA™* (8800)</p> <p><b>ANSI/BHMA Numbers:</b> E09321, E09322, E09323</p>	
<p><b>OPERATION</b></p>	 <p>Mortise Locks with Deadbolt</p>	<p>Lockout function. The electric strike will not release if the deadbolt is extended. The deadbolt is retracted during traffic hours. The latchbolt is released by the keeper. The keeper returns to the locked position.</p>
 <p>4-7/8" × 1-1/4" [123.8mm x 31.75mm]</p>	<p><b>HM Option</b></p> <p><b>For use with:</b> Mortise locksets with a 1" deadbolt. Strike will not release when deadbolt is extended.</p> <p><b>Compatible locksets:</b> Accurate, Arrow, Baldwin, Best, Corbin Russwin, Falcon (45H, 47H, 34H &amp; 37H), Marks, Omnia, PDQ, Sargent (7800, 8200 &amp; 9200), ASSA ABLOY ACCENTRA™* (8800)</p> <p><b>ANSI/BHMA Numbers:</b> 09391, E09392, E09393, E09331, E09332, E09333</p>	
 <p>4-7/8" × 1-1/4" [123.8mm x 31.75mm]</p>	<p><b>HTD Option</b></p> <p><b>For use with:</b> Mortise locksets with a 1" deadbolt and no deadlatch or a center positioned deadlatch. Strike will not release when deadbolt is extended.</p> <p><b>Compatible locksets:</b> Sargent (7700 &amp; 8100), Schlage, ASSA ABLOY ACCENTRA™* (8700)</p> <p><b>ANSI/BHMA Numbers:</b> E09391, E09392, E09393, E09331, E09332, E09333</p>	

\* Formerly Yale Commercial

"For use with" information is offered as a recommendation only. Reference should be made to the lockset manufacturer for proper installation instructions necessary to meet compatibility requirements.

# 1006 Series Faceplate Options

<p><b>OPERATION</b></p>	 <p>Mortise Locks with Deadbolt</p>	<p>Night latch function. The deadbolt is retracted during traffic hours. The latchbolt is released by the keeper and keeper returns to the locked position.</p>
 <p>4-7/8" x 1-1/4" [123.8mm x 31.75mm]</p>	<p><b>ND Option</b></p> <p><b>For use with:</b> Mortise locksets with a deadbolt used for night latch function only.</p> <p><b>Compatible locksets:</b> Sargent (7700 &amp; 8100), Schlage, ASSA ABLOY ACCENTRA™* (8700)</p> <p><b>ANSI/BHMA Numbers:</b> E09391, E09392, E09393, E09331, E09332, E09333</p>	
 <p>4-7/8" x 1-1/4" [123.8mm x 31.75mm]</p>	<p><b>NM Option</b></p> <p><b>For use with:</b> Mortise locksets with a deadbolt used for night latch function only.</p> <p><b>Compatible locksets:</b> Accurate, Arrow, Baldwin, Best, Corbin Russwin, Falcon (45H, 47H, 34H &amp; 37H), Marks, Omnia, PDQ, Sargent (7800, 8200 &amp; 9200), ASSA ABLOY ACCENTRA™* (8800)</p> <p><b>ANSI/BHMA Numbers:</b> E09391, E09392, E09393, E09331, E09332, E09333</p>	

\* Formerly Yale Commercial

The following legacy faceplate options remain available for order. Suggestions are provided below for more versatile options.

<p><b>H Option</b> replaced by <b>HM Option</b></p>	<p><b>A-2 Option</b> replaced by <b>CAS-2 Option</b></p>
<p><b>HD Option</b> replaced by <b>HTD Option</b></p>	<p><b>H-2 Option</b> replaced by <b>DB-2 Option</b></p>
<p><b>HT Option</b> replaced by <b>HTD Option</b></p>	<p><b>N-2 Option</b> replaced by <b>DB-2 Option</b></p>
<p><b>K Option</b> replaced by <b>KM Option</b></p>	<p><b>T-2 Option</b> replaced by <b>CAS-2 Option</b></p>
<p><b>K-2 Option</b> combined into <b>KM-2 Option</b></p>	

# 1006 Series Faceplate Option Dimensions

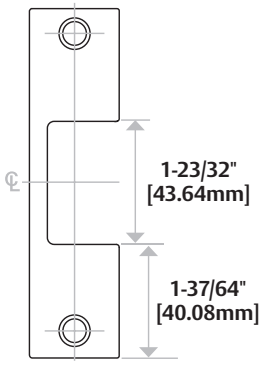
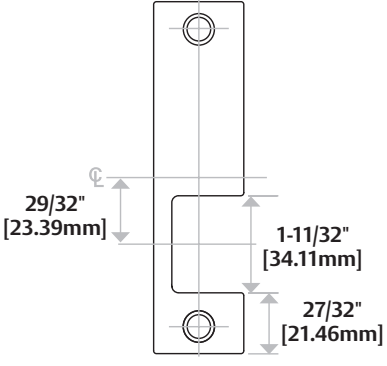
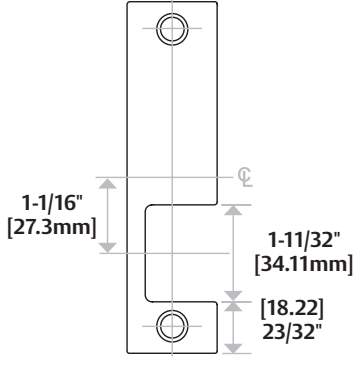
J, E	K	KD
 <p>1-23/32" [43.64mm]</p> <p>1-37/64" [40.08mm]</p>	 <p>29/32" [23.39mm]</p> <p>1-11/32" [34.11mm]</p> <p>27/32" [21.46mm]</p>	 <p>1-1/16" [27.3mm]</p> <p>1-11/32" [34.11mm]</p> <p>18.22" 23/32"</p>

"For use with" information is offered as a recommendation only. Reference should be made to the lockset manufacturer for proper installation instructions necessary to meet compatibility requirements.

